

224,270

CABINET FOR KEYBOARD INSTRUMENT OR THE LIKE

Salvatore Merendino, Pasadena, Edward Barczak, Los Angeles, and Adolph D. Lambach, Fountain Valley, Calif., assignors to Mattel, Inc., Hawthorne, Calif.

Filed Jan. 11, 1971, Ser. No. 105,793

Term of patent 14 years

Int. Cl. D17-01

U.S. Cl. D56-2

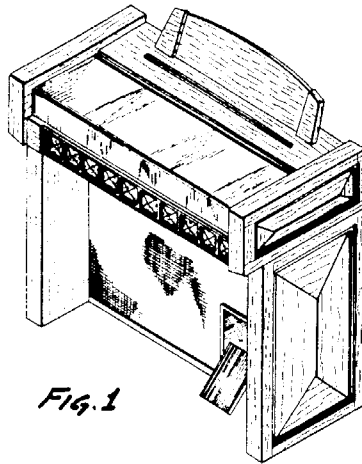

Fig. 1

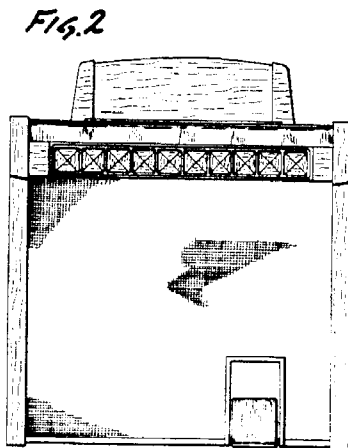

Fig. 2

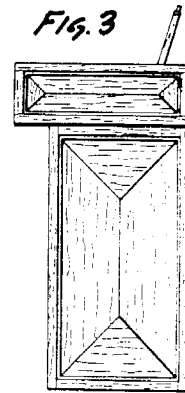

Fig. 3

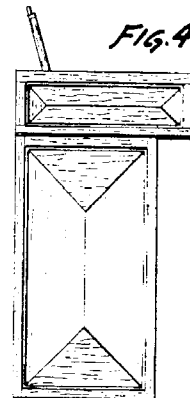

Fig. 4

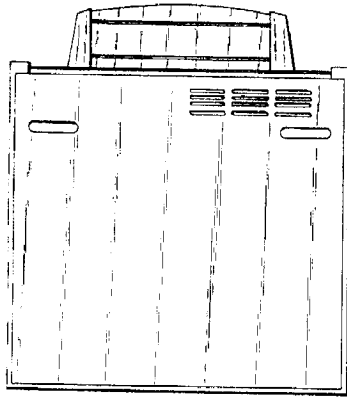

FIG. 7

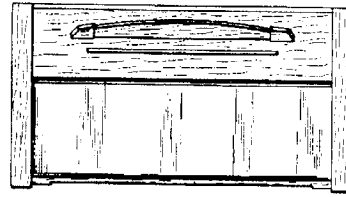

FIG. 5

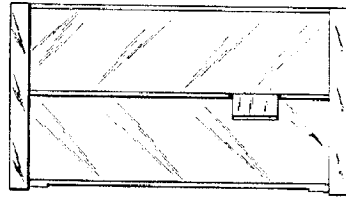

FIG. 6

FIG. 1 is a perspective view of a cabinet for a keyboard instrument or the like, showing our new design;

FIG. 2 is a front elevational view;

FIG. 3 is a right side elevational view; and

FIG. 4 is a left side elevational view;

FIG. 5 is a top plan view;

FIG. 6 is a bottom plan view; and

FIG. 7 is a rear elevational view thereof.

The grille cover fragmentarily shown in criss-cross lines in FIGS. 1 and 2 is continuous within the boundaries.

We claim:

The ornamental design for a cabinet for keyboard instrument or the like, as shown and described.

References Cited

UNITED STATES PATENTS

2,197	10/1865	Treat	-----	D56—2
218,482	8/1970	Warren et al.	-----	D56—2

OTHER REFERENCES

Piano Trade Magazine, September 1962, page 27, Estey model 700P organ.

JOEL STEARMAN, Primary Examiner

W. M. HENRY, Assistant Examiner